

# HELATUKKU

## *Collection*

VEDINKUVASTO



**NEW CLASSICS**

TIMELESS AND FUNCTIONAL DESIGN

**INVISIBLE COLORS**

APPEALING DESIGN AND SCANDINAVIAN LIGHTNESS

**DESIGN MATCH**

SOULMATE OF NATURE AND DARK TONES

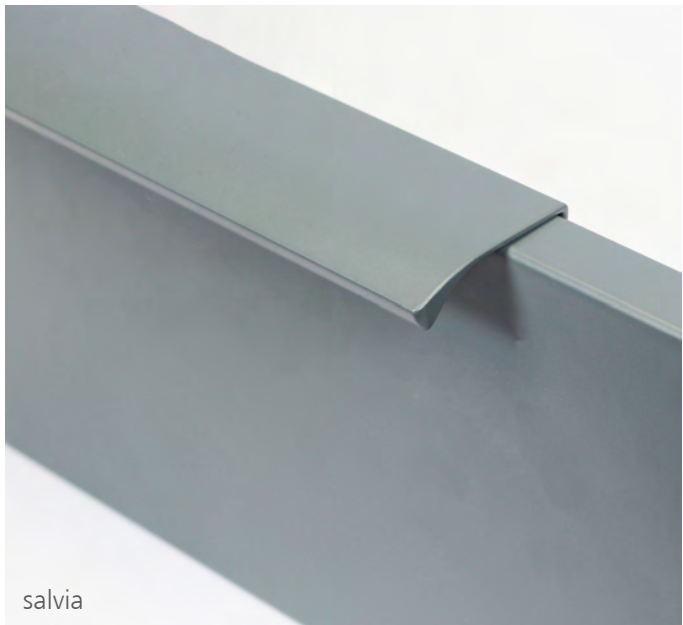

salvia



mocca

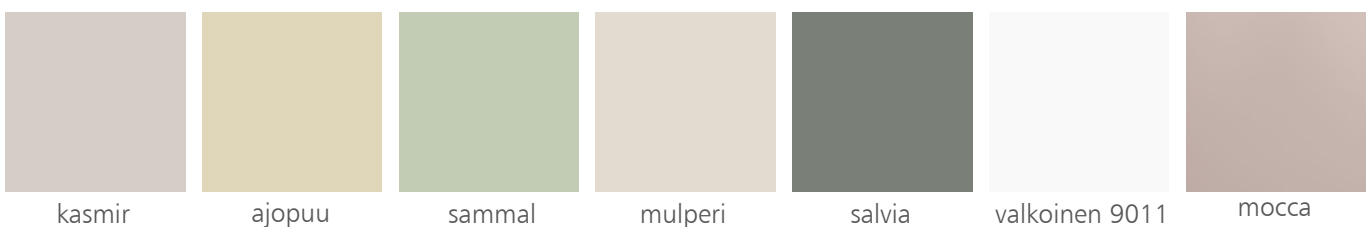

kasmir

ajopuu

sammal

mulperi

salvia

valkoinen 9011

mocca



kasmir

## Ligo

tuotenro nimike

- 022100 Ø35 mm kasmir
- 022101 Ø35 mm ajopuu
- 022102 Ø35 mm sammal
- 022103 Ø35 mm mulperi
- 022104 Ø35 mm salvia
- 022105 Ø35 mm valkoinen 9011
- 022106 Ø35 mm mocca

-	-	26	-	35	-





sammal

## Antica

tuotenro nimike

022110	128 mm kasmir
022111	128 mm ajopuu
022112	128 mm sammal
022113	128 mm mulperi
022114	128 mm salvia
022115	128 mm valkoinen 9011
022116	128 mm mocca

128	141	34	6,5	-	-





mocca

## Wing

tuotenro nimike

022120	200 mm kasmir
022121	200 mm ajopuu
022122	200 mm sammal
022123	200 mm mulperi
022124	200 mm salvia
022125	200 mm valkoinen 9011
022126	200 mm mocca

80/80	200	41	18	-	-

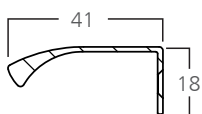



## Basic

tuotenro nimike

022209 96 mm rst

022208 128 mm rst

					
96	107	32	-	10	50
128	138	32	-	10	50



\* Tuote on poistumassa.  
Tarkista valikoima verkkokaupasta tai myynnistä.



## Cavo mini

tuoteno nimike

025420 128 mm musta

025421 160 mm musta

025440 Cavo mini + aluslaatta 128 mm musta

025441 Cavo mini + aluslaatta 160 mm musta



Ø	Ø	Ø	Ø	Ø	Ø
128	134	30	-	6	-
160	166	30	-	6	-



## Retro

tuotenro nimike

- 022230 96 mm kromi
- 022231 96 mm valkoinen
- 022232 96 mm musta
- 022233 96 mm messingöity

96	110	30	-	6	-







## Wire

tuotenro nimike

022270 128 mm rst-look  
 022271 128 mm kromi  
 022272 128 mm harjattu messinki  
 022273 128 mm musta

022275 160 mm rst-look  
 022276 160 mm kromi  
 022277 160 mm harjattu messinki  
 022278 160 mm musta

025450 128 mm musta + aluslaatta  
 025451 160 mm musta + aluslaatta

Ø	Ø	Ø	Ø	Ø	Ø
128	136	30	-	5,5	-
160	168	30	-	5,5	-





### Tube

tuotenro nimike

- 022235 160 mm kromi
- 022236 160 mm rst-look
- 022237 160 mm musta
- 022238 160 mm messingöity

160	174	35	-	8	-



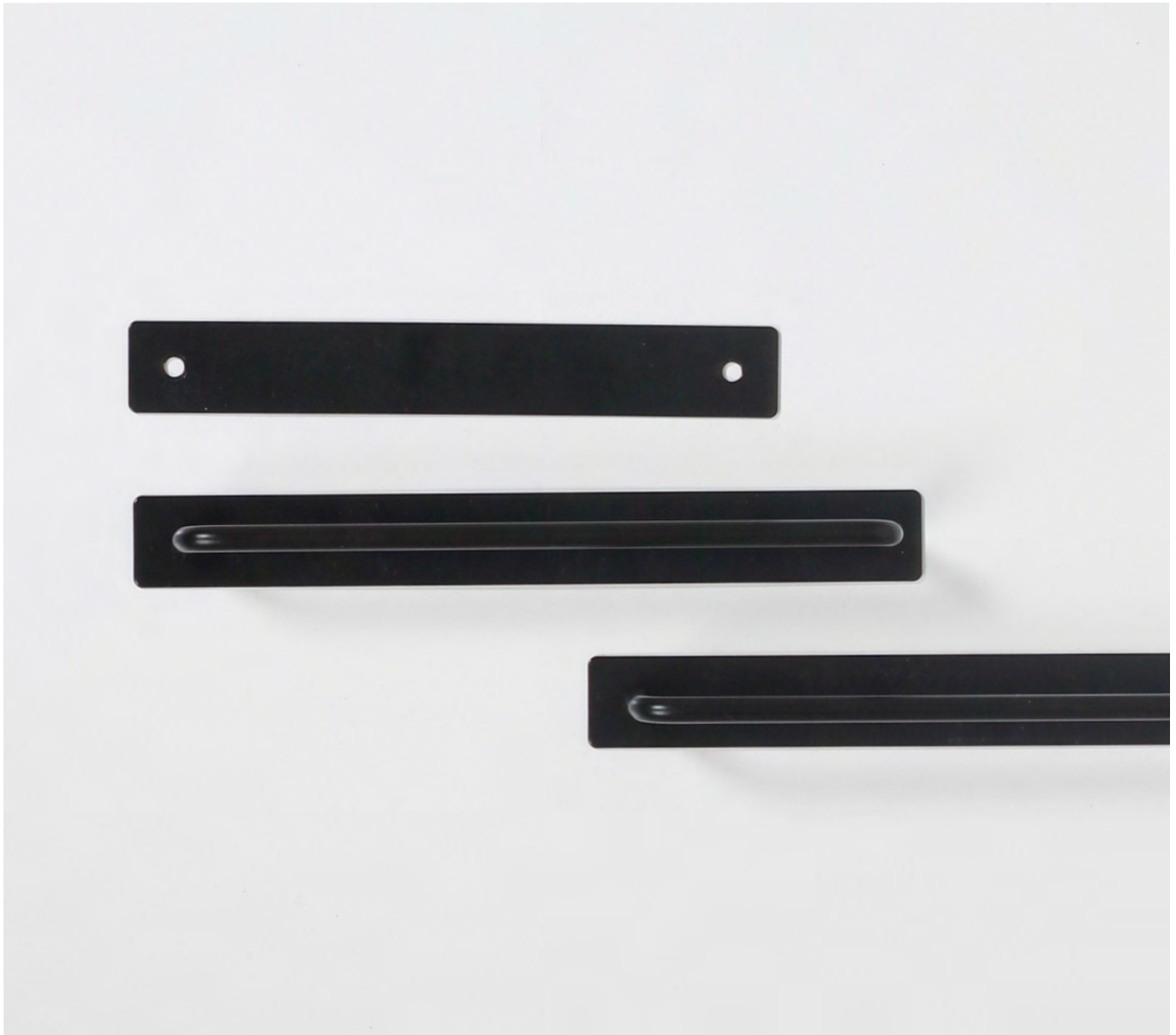

## Vetimen aluslaatta

tuotenro nimike

025430 128 mm musta

025431 160 mm musta

*Musta aluslaatta vetimille. Voi yhdistellä esim lankavetimien Wire ja Cavo mini kanssa.*





## Cubix

## tuotenro nimike

026187 32 mm rst-look  
 026194 96 mm rst-look  
 026200 128 mm rst-look  
 026206 160 mm rst-look  
 026208 256 mm rst-look  
 026216 320 mm rst-look  
 026212 448 mm rst-look

026188 32 mm kromattu  
 026195 96 mm kromattu  
 026201 128 mm kromattu  
 026204 160 mm kromattu  
 026209 256 mm kromattu  
 026217 320 mm kromattu  
 026213 448 mm kromattu

026189 32 mm valkoinen  
 026196 96 mm valkoinen  
 026198 128 mm valkoinen  
 026203 160 mm valkoinen  
 026210 256 mm valkoinen  
 026218 320 mm valkoinen  
 026214 448 mm valkoinen

026190 32 mm musta  
 026197 96 mm musta  
 026199 128 mm musta  
 026207 160 mm musta  
 026211 256 mm musta  
 026219 320 mm musta  
 026215 448 mm musta

026202 128 mm kupari  
 026221 192 mm kupari

026258 128 mm harjattu kupari  
 026259 192 mm harjattu kupari

026252 128 mm antiikki musta  
 026253 192 mm antiikki musta

026282 128 mm gunmetal  
 026284 192 mm gunmetal

⊕	⌒	⌒	⌒	⌒	⌒	⌒
32	41	28	9	-	25	
96	105	28	9	-	25	
128	137	28	9	-	25	
160	169	28	9	-	25	
192	201	28	9	-	25	
256	264	28	9	-	25	
320	329	28	9	-	25	
448	457	28	9	-	25	





### Cubix soft

tuotenro nimike

- 027560 128 mm rst-look
- 027570 160 mm rst-look
- 027571 160 mm kromi
- 027572 160 mm harjattu messinki
- 027573 160 mm musta

128	135	28	-	9	-
160	167	28	-	9	-





## Milo

tuotenro nimike

026447	96 mm	rst-look
026450	128 mm	kromi
026451	128 mm	rst-look
026452	128 mm	valkoinen kiiltävä
026453	128 mm	musta
026460	192 mm	kromi
026461	192 mm	rst-look
026462	192 mm	valkoinen kiiltävä
026463	192 mm	musta
026470	288 mm	kromi
026471	288 mm	rst-look
026472	288 mm	valkoinen kiiltävä
026473	288 mm	musta
026474	384 mm	rst-look
026475	384 mm	kromi
026476	384 mm	musta
026477	384 mm	valkoinen kiiltävä
026485	520 mm	kromi *



Ø	Ø	Ø	Ø	Ø	Ø
96	103	27	12	-	-
128	135	27	12	-	-
192	199	27	12	-	-
288	295	27	12	-	-
384	391	27	12	-	-
520	532	27	14	-	-



### Max

tuotenro nimike

026261	160 mm rst-look
026262	160 mm musta nikkeli
026263	160 mm antiikki rauta
026264	160 mm antiikki ruskea
026265	288 mm rst-look
026266	288 mm musta nikkeli
026267	288 mm antiikki rauta
026268	288 mm antiikki ruskea

160 288	168 296	30 30	28 28	-	-







## Alfa

tuotenro nimike

022240	160 mm rst-look
022241	160 mm musta
022242	160 mm antiikkiruskea
022243	160 mm harjattu messinki
022244	160 mm harjattu kupari

160	168	31	10	-	-





## Beta

tuotenro nimike

027505 160 mm rst-look  
 027506 160 mm matta musta  
 027507 160 mm harjattu tumma messinki

027516 256 mm matta musta  
 027517 256 mm rst-look  
 027518 256 mm tumma messinki

160	167	30	17	-	-
256	263	30	17	-	25





## Beta mini

tuotenro nimike

027540	128 mm kromi
027541	128 mm rst-look
027542	128 mm musta
027543	128 mm valkoinen
027544	128 mm himm.messinki

027545	160 mm kromi
027546	160 mm rst-look
027547	160 mm musta
027548	160 mm valkoinen
027549	160 mm himm.messinki











## Sense

tuotenro nimike

027510 128 mm rst-look  
 027512 320 mm rst-look  
 027514 480 mm rst-look  
 027511 128 mm musta  
 027513 320 mm musta  
 027515 480 mm musta

					
128	135	25	29,5	-	-
320	327	25	29,5	-	-
480	487	25	29,5	-	-

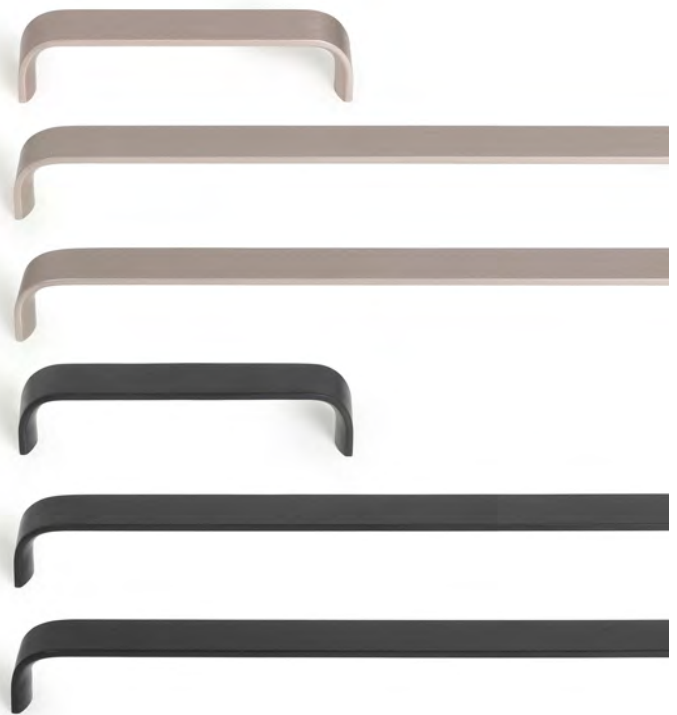



## Track

tuotenro nimike

022305	160 mm kromi
022306	160 mm rst-look
022307	160 mm matta musta
022308	160 mm harjattu kupari
022309	160 mm harjattu messinki
022310	160 mm antrasiitti

160	172	30	10	-	-





**Slick**

tuotenro nimike

- 022260 160 mm rst-look
- 022261 160 mm matta musta
- 022262 160 mm harjattu messinki

160	172	30	12	-	-

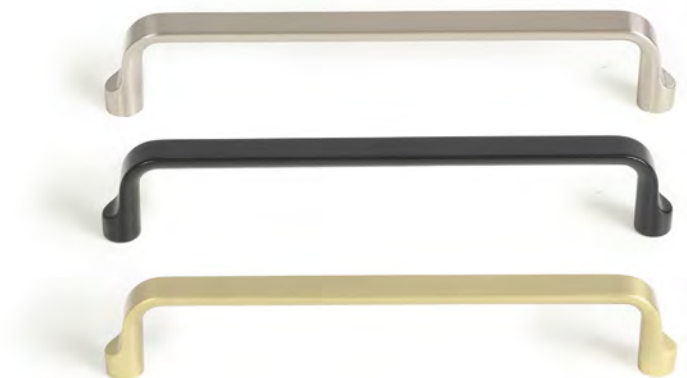



## Pura

tuotenro nimike

022314 160 mm messinki

022315 160 mm kromi

022316 160 mm musta nikkeli

160	168	28	8	-	25

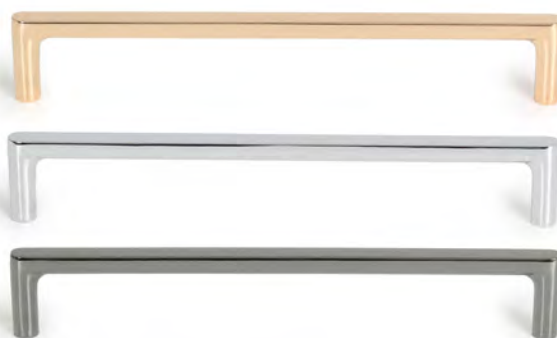



## Redo

tuotenro nimike

- 022335 128 mm rst-look  
 022336 128 mm antiikki tina  
 022337 128 mm antiikki messinki

128	137	32	15	-	25





## Cavo

tuotenro nimike

022210	96 mm kromi
022211	128 mm kromi
022212	160 mm kromi
022213	160 mm matta kromi
022214	256 mm kromi
022215	352 mm kromi
022216	448 mm kromi

96	104	30	-	8
128	136	30	-	8
160	168	30	-	8
256	264	30	-	8
352	360	30	-	8
448	456	30	-	8



## Stilo

tuotenro nimike

022625	160 mm rst-look
028345	160 mm matta kromi

160	170	26	22	-



## Titan

tuotenro nimike

026160	96 ja 128 mm matta kromi
026162	192 mm matta kromi
026164	320 mm matta kromi
026166	96 ja 128 mm rst-look
026168	192 mm rst-look
026170	320 mm rst-look

96/128	138	28	9	-
192	224	28	9	-
320	352	28	9	-

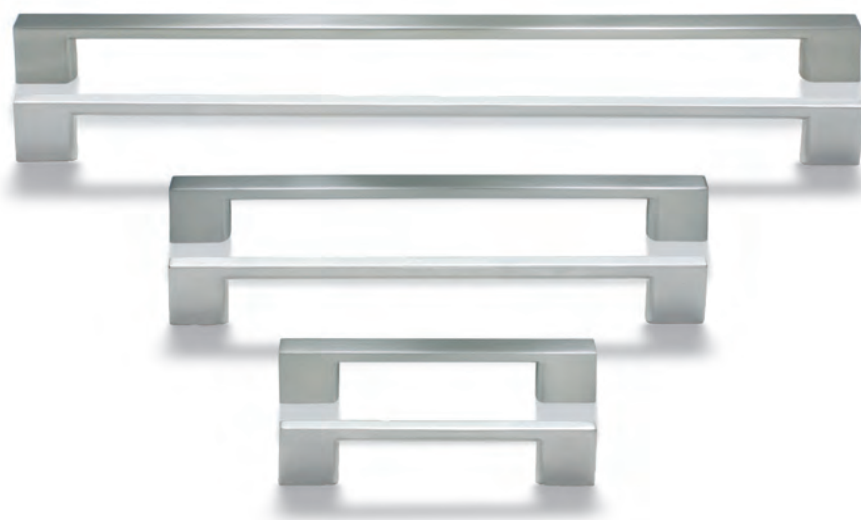

### Gina

tuotenro nimike

026255 Vedin 128 mm rst-look

026257 Vedin 192 mm rst-look

128	147	33	8	-	-
192	211	33	8	-	-



### Cella

tuotenro nimike

026185 160 mm kromi

160	169	37	8	-	-



### Saga

tuotenro nimike

026656 128 mm kromi

026657 128 mm mattakromi

026658 128 mm rst-look

026659 320 mm kromi

026660 320 mm rst-look

128	156	26	8	-	-
320	348	26	8	-	-



## Amon

tuotenro nimike

022608	10x96 mm kromi
022609	10x96 mm matta kromi
022611	10x128 mm matta kromi
025521	10x128 mm kromi

					
96 128	114 153	28 30	10 10	- -	25 25



## Venus

tuotenro nimike

025513	128 mm matta nikkeli
025515	96 mm matta nikkeli

					
96 128	117 152	30 30	20 20	- -	25 25



## Apollo

tuotenro nimike

026075	96 mm matta kromi
026078	128 mm matta kromi





					
96 128	126 162	23 23	11 13	- -	25 25



## Gamma

tuotenro nimike

026000	96 mm matta kromi
026002	128 mm matta kromi
025993	96 mm rst-look
025994	128 mm rst-look

					
96 128	111 159	23 23	8 10	- -	50 25



### Lancelot

tuotenro nimike

025622 96 mm matta nikkeli \*

025627 128 mm matta nikkeli \*

					
96	114	24	12	-	50
128	145	24	14	-	50



### Zara

tuotenro nimike

026536 128 mm matta nikkeli

026537 128 mm rst-look

					
128	155	26	18	-	25



### Ego

tuotenro nimike

026519 96 mm matta kromi

026538 96 mm rst-look

026520 128 mm matta kromi

026539 128 mm rst-look

					
96	109	26	15	-	-
128	140	28	16	-	30



### Stella

tuotenro nimike

026175 128 mm matta kromi

026176 128 mm rst-look

026177 128 mm kromi

026178 224 mm rst-look

026179 224 mm kromi

					
128	149	31	15	-	25
224	245	31	15	-	25



\* Tuote on poistumassa.  
Tarkista valikoima verkkokaupasta tai myynnistä.

## Tino

tuotenro nimike

026222	128 mm kromi
026223	128 mm rst-look
026248	160 mm kromi
026249	160 mm rst-look
026250	224 mm kromi
026251	224 mm rst-look

Ø	Ø	Ø	Ø	Ø	Ø
128	141	23	21	-	-
160	172	23	21	-	-
224	237	23	21	-	-



## Doris

tuotenro nimike

026303	64 mm kromi *
026308	96 mm kromi *
026312	128 mm kromi *
026316	160 mm kromi *
026323	256 mm kromi *
026330	320 mm kromi *
026333	448 mm kromi *

026304	64 mm musta *
026309	96 mm musta *
026313	128 mm musta *
026317	160 mm musta *
026324	256 mm musta *
026331	320 mm musta *
026334	448 mm musta *

026310	96 mm valkoinen *
026314	128 mm valkoinen *
026318	160 mm valkoinen *
026325	256 mm valkoinen *
026332	320 mm valkoinen *
026335	448 mm valkoinen *

Ø	Ø	Ø	Ø	Ø	Ø
64	86	19	7	-	-
96	116	25	8	-	-
128	150	31	8	-	-
160	186	31	8	-	-
256	284	37	8	-	-
320	352	39	8	-	-
448	448	45	9	-	-





### Graf mini

tuotenro nimike

022320 160 mm tumma messinki

022321 160 mm musta harjattu

022322 160 mm rst-look

160	182	33	10	-	25





## Pax

tuotenro nimike

026107	128 mm rst
026108	160 mm rst
026110	256 mm rst
026113	448 mm rst







128	138	30	-	10	-
160	170	30	-	10	-
256	266	30	-	10	-
448	458	30	-	10	-



### Orion

tuotenro nimike

026008	Nuppi rst-look
026010	96/136 mm rst-look
026020	96/176 mm rst-look
026021	128/208 mm rst-look
026022	160/240 mm rst-look
026023	192/272 mm rst-look
026024	236/316 mm rst-look
026025	336/416 mm rst-look
026026	436/516 mm rst-look *
026027	636/716 mm rst-look *



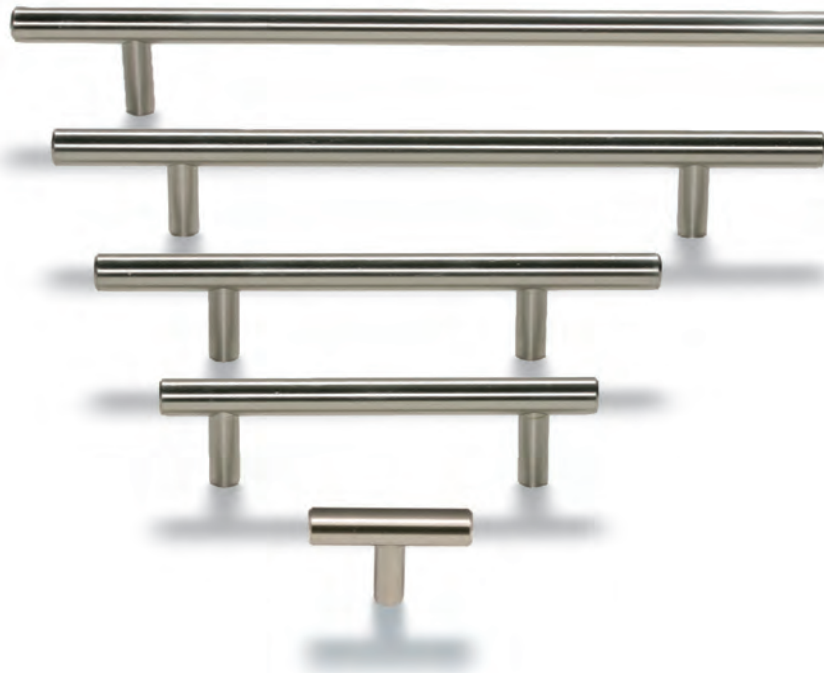



					
-	50	35	-	12	-
96	136	35	-	12	20
96	176	35	-	12	20
128	208	35	-	12	20
160	240	35	-	12	20
192	272	35	-	12	20
236	316	35	-	12	10
336	416	35	-	12	10
436	516	35	-	12	10
636	716	35	-	12	5



### Vector

tuotenro nimike

026570	128 mm anodisoitu alumiini
026571	192 mm anodisoitu alumiini
026572	292 mm anodisoitu alumiini
026573	392 mm anodisoitu alumiini
026574	492 mm anodisoitu alumiini *
026575	692 mm anodisoitu alumiini *
026576	892 mm anodisoitu alumiini *

					
128	158	35	-	12	25
192	222	35	-	12	25
292	322	35	-	12	25
392	422	35	-	12	25
492	522	35	-	12	25
692	722	35	-	12	25
892	922	35	-	12	25









\* Tuote on poistumassa.  
Tarkista valikoima verkkokaupasta tai myynnistä.



## Meta

tuotenro nimike

026540	128 mm anodisoitu alumiini
026542	192 mm anodisoitu alumiini
026543	292 mm anodisoitu alumiini
026544	392 mm anodisoitu alumiini
026545	492 mm anodisoitu alumiini *
026546	692 mm anodisoitu alumiini *
026547	892 mm anodisoitu alumiini *

					
128	140	36	16	-	20
192	204	36	16	-	25
292	304	36	16	-	25
392	404	36	16	-	20
492	504	36	16	-	10
692	704	36	16	-	10
892	904	36	16	-	10



### Rut

tuotenro nimike

025529	64 mm antiikki tina
025533	64 mm antiikki messinki
025534	64 mm rst-look
025535	64 mm kromi

					
64	95	20	27	-	25



### Cappa

tuotenro nimike

026236	32 mm rst-look
026237	32 mm antiikki rauta
026238	96 mm rst-look
026239	96 mm antiikki rauta

					
32 96	51 116	19 19	27 27	- -	- -

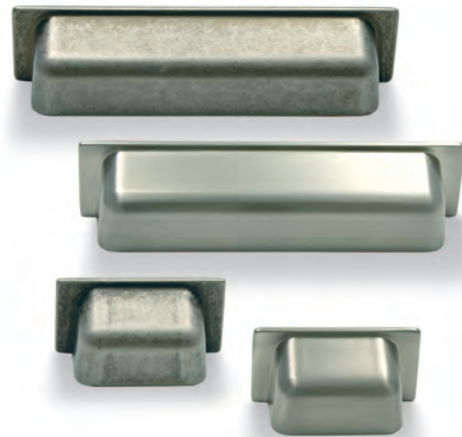



## Firm

tuotenro nimike

022317 96 mm musta

022318 160 mm musta

022319 320 mm musta

⌀	⌒	⌒	⌒	●	▲
96	126	30	25	-	25
160	190	30	25	-	25
320	350	30	25	-	25





## Antica

tuotenro nimike

025400 96 mm harjattu messinki  
 025401 96 mm antiikki musta  
 025402 96 mm antiikki messinki  
 025403 96 mm gunmetal  
 025404 96 mm kromi

025406 128 mm harjattu messinki  
 025407 128 mm antiikki musta  
 025408 128 mm antiikki messinki  
 025409 128 mm gunmetal  
 025410 128 mm kromi

025412 160 mm harjattu messinki  
 025413 160 mm antiikki musta  
 025414 160 mm antiikki messinki  
 025415 160 mm gunmetal  
 025416 160 mm kromi

Ø	Ø	Ø	Ø	Ø	Ø
96	109	34	6,5	-	-
128	141	34	6,5	-	-
160	173	34	6,5	-	-





## Button

tuotenro nimike

- 022330 160 mm kromi
- 022331 160 mm antiikki tina
- 022332 160 mm antiikki messinki
- 022333 160 mm matta musta

160	175	25	17	-	25





## Floid

tuotenro nimike

- 022345 Vedin 192 mm harjattu kulta  
 022346 Vedin 192 mm antiikki tina  
 022347 Vedin 192 mm antiikki messinki  
 022348 Vedin 192 mm matta musta

192	208	31	16	-	25





## Loft

tuotenro nimike  
027001 160 mm antiikki musta

160	180	30	10	-	-







## Tacu

tuotenro nimike

026818 128 mm antiikki rauta (91135)

026820 128 mm antiikki messinki (91135)

128	155	25	20	-	50



## Ticu

tuotenro nimike

026819 16 mm antiikki rauta (91136)

026821 16 mm antiikki messinki (91136)

16	66	25	16	-	50



### Kansas

tuotenro nimike

026125	Vedin 96 mm antiikki messinki
026126	Vedin 96 mm antiikki tina
026128	Nuppi antiikki messinki
026129	Nuppi antiikki tina

96	122	30	25	-	25
-	50	25	21	-	25



### Tessa

tuotenro nimike

026230	96 mm kromi
026231	96 mm rst-look
026232	96 mm antiikki rauta

96	145	28	28	-	25



### Ava

tuotenro nimike

027520	96 mm antiikki tina
027521	96 mm antiikki messinki

96	128,5	26	29	8	-





## Ball

tuotenro nimike

026244 Ø31 mm musta

026245 Ø31 mm rst-look

026246 Ø31 mm kromi

026247 Ø31 mm messinki

-	-	28	-	31	25





## Ligo

tuotenro nimike

- 022245 Ø35 mm kromi
- 022246 Ø35 mm rst-look
- 022247 Ø35 mm musta
- 022248 Ø35 mm messingöity
- 022249 Ø35 mm harjattu messinki
- 022250 Ø35 mm valkoinen
- 022251 Ø35 mm harjattu kupari

-	-	26	-	35	-





## Camon

tuotenro nimike

- 026510 Ø26 mm rst-look  
 026511 Ø26 mm matta musta  
 026512 Ø26 mm harjattu kupari  
 026513 Ø26 mm harjattu messinki  
 026514 Ø26 mm valkoinen

-	-	18	-	26	-





## Thing

tuotenro nimike

- 022295 Ø41 mm kromi
- 022296 Ø41 mm rst-look
- 022297 Ø41 mm matta musta
- 022298 Ø41 mm harjattu kupari
- 022299 Ø41 mm harjattu messinki

-	-	25	-	41	





## Pole

tuotenro nimike

022287 Ø10 mm harjattu musta

022288 Ø10 mm rst-look

022289 Ø10 mm harjattu tumma messinki

-	-	33	-	10	-





### Tune

tuotenro nimike

022255 Ø17,5 mm matta musta

022256 Ø17,5 mm rst-look

022257 Ø17,5 mm harjattu messinki

-	-	28	-	17,5	-







## Comp

tuotenro nimike

022280 Ø38 mm harjattu musta

022281 Ø38 mm rst-look

022282 Ø38 mm harjattu tumma messinki

-	-	30	-	38	-





### Floid

tuotenro nimike

- 022339 Nuppi Ø30 mm harjattu kulta
- 022340 Nuppi Ø30 mm antiikki tina
- 022341 Nuppi Ø30 mm antiikki messinki
- 022342 Nuppi Ø30 mm musta

-	-	30	-	35	25



## Freia

tuotenro nimike

025580 Ø33 mm matta nikkeli

025581 Ø33 mm kromi

-	-	26	-	33	50



## Noca

tuotenro nimike

026270 Rst-look

16	39	23	22	-	-



## Dito

tuotenro nimike

028012 Ø12 mm kromi

028016 Ø12 mm matta kromi

028017 Ø12 mm rst-look

-	-	24	-	12	100



## Ariel

tuotenro nimike

026890 Ø16 mm antrasiitti

026891 Ø16 mm rst-look

-	-	22	-	16	-





## Tee

tuotenro nimike

023105 Ø50 mm tammi lakattu

023106 Ø50 mm musta värjätty

-	-	20	-	50	





## Lex

tuotenro nimike

- 023130 Ø33mm lakattu tammi  
 023131 Ø33mm musta  
 023135 Ø48mm lakattu tammi  
 023136 Ø48mm musta

±	⌒	⌒	⌒	●	▲
-	-	28	-	33	-
-	-	41	-	48	-





### Tac

tuotenro nimike

023150 Ø38 mm tammi

023151 Ø38 mm musta

023152 Ø38 mm pähkinä

-	-	27,5	-	38	





## Duffy

tuotenro nimike

023100 192 mm lakattu puuvedin tammi

023101 192 mm lakattu puuvedin musta

192	240	33	19	-	-





## Surf

tuotenro nimike

023110 160 mm lakattu puuedin tammi

023111 160 mm lakattu puuedin musta

160	224	24	28	-	-







## Nike

tuotenro nimike

023120 64 mm lakattu tammi

023121 64 mm musta

023125 160 mm lakattu tammi

023126 160 mm musta

☉	☉	☉	☉	☉	☉
64	80	25	16	-	-
160	176	25	16	-	-





## Woody

tuotenro nimike

023090 160 mm lakattu puuedin tammi

023091 224 mm lakattu puuedin tammi

160	215	35	10	-	-
224	285	35	10	-	-





## Tao

tuotenro nimike

023145 256 mm lakattu pähkinä



265	300	20	12	-	-



## Leon

tuotenro nimike

026350 128 mm natur (vaalea nahka) / kromi

026351 128 mm ruskea / kromi

026352 128 mm musta / kromi

Korkealaatuista kasvivärjättyä nahkaa kromatuilla kiinnitysholkeilla.

128	154	19	25	-	-



## Lungo

tuotenro nimike

026589 40 mm alumiini anodisoitu  
 026590 136 mm alumiini anodisoitu  
 026591 235 mm alumiini anodisoitu  
 026592 335 mm alumiini anodisoitu  
 026593 435 mm alumiini anodisoitu

026625 40 mm valkoinen  
 026627 136 mm valkoinen  
 026629 235 mm valkoinen  
 026631 335 mm valkoinen  
 026633 435 mm valkoinen  
 026635 535 mm valkoinen

026626 40 mm musta  
 026628 136 mm musta  
 026630 235 mm musta  
 026632 335 mm musta  
 026634 435 mm musta  
 026636 535 mm musta

026645 40 mm rst-look  
 026646 136 mm rst-look  
 026647 235 mm rst-look  
 026648 335 mm rst-look  
 026649 435 mm rst-look

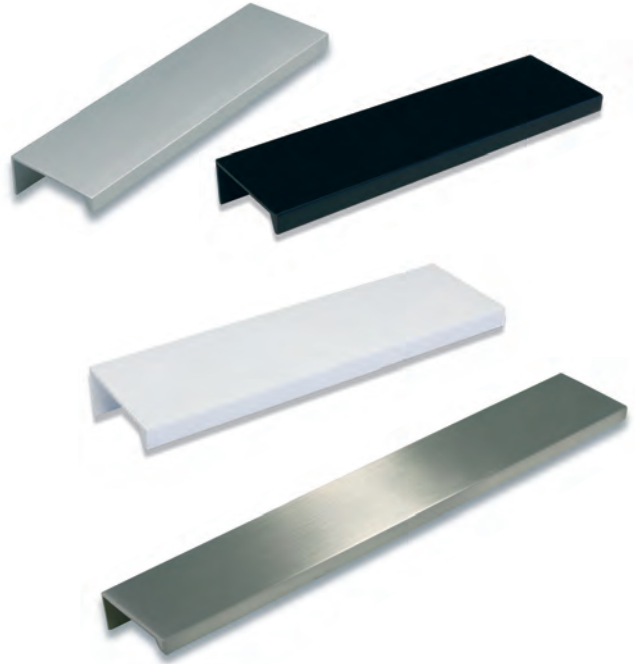

Ø	Ø	α	β	h	•	▲
20	40	40	18	-	-	-
96	136	40	18	-	-	-
195	235	40	18	-	-	-
295	335	40	18	-	-	-
395	435	40	18	-	-	-
247/247	535	40	18	-	-	-

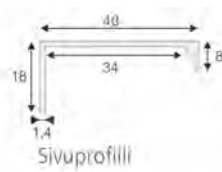

### Remus

tuotenro nimike

026884 160 mm antrasiitti

026885 160 mm rst-look

026887 320 mm antrasiitti

026888 320 mm rst-look

⊕	⤴	⤵	⤴	⤵	●	▲
160	168	27	8	-	-	
320	328	27	8	-	-	



### Ponte

tuotenro nimike

026850 160/192 mm antiikkikupari (81068) \*

026851 128 mm antiikkikupari (81068)

026852 128 mm kromi (81068) \*

026853 128 mm antiikkirauta (81068)

026854 320/288 mm kromi (81068) \*

026855 320/288 mm antiikkirauta (81068) \*

026856 128 mm antras. matta (81068)

⊕	⤴	⤵	⤴	⤵	●	▲
128	166	25	35	-	-	
160/192	238	25	35	-	-	
320/288	366	31	35	-	-	

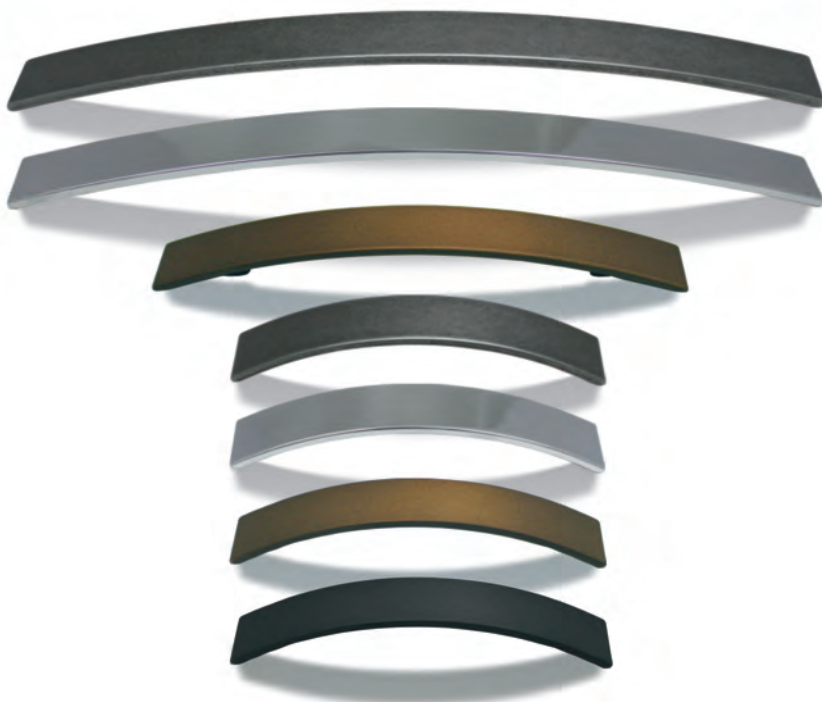

## Mirror

tuotenro nimike

026115 Kromattu sis. jousen 6 mm:n lasille/peilille

-	38	17	22	-	-



Mirror ja 6 mm:n jousi



### Norma I6mm

#### tuotenro nimike

025700 195,5 mm anod. alumiini  
 025701 295,5 mm anod. alumiini  
 025702 395,5 mm anod. alumiini  
 025703 495,5 mm anod. alumiini  
 025704 595,5 mm anod. alumiini  
 025705 695,5 mm anod. alumiini  
 025706 795,5 mm anod. alumiini  
 025707 895,5 mm anod. alumiini  
 025708 995,5 mm anod. alumiini

025710 195,5 mm valkoinen  
 025711 295,5 mm valkoinen  
 025712 395,5 mm valkoinen  
 025713 495,5 mm valkoinen  
 025714 595,5 mm valkoinen  
 025715 695,5 mm valkoinen  
 025716 795,5 mm valkoinen  
 025717 895,5 mm valkoinen  
 025718 995,5 mm valkoinen

025720 195,5 mm musta  
 025721 295,5 mm musta  
 025722 395,5 mm musta  
 025723 495,5 mm musta  
 025724 595,5 mm musta  
 025725 695,5 mm musta  
 025726 795,5 mm musta  
 025727 895,5 mm musta  
 025728 995,5 mm musta

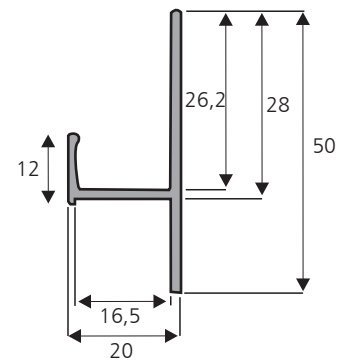
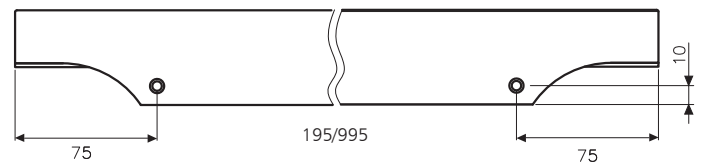

Ø	Ø	h	h	h	h	h
-	195,5	20	26,2/50	-	-	-
-	295,5	20	26,2/50	-	-	-
-	395,5	20	26,2/50	-	-	-
-	495,5	20	26,2/50	-	-	-
-	595,5	20	26,2/50	-	-	-
-	695,5	20	26,2/50	-	-	-
-	795,5	20	26,2/50	-	-	-
-	895,5	20	26,2/50	-	-	-
-	995,5	20	26,2/50	-	-	-





### Norma I8mm

tuotenro nimike

025750 195,5 mm anod. alumiini  
 025751 295,5 mm anod. alumiini  
 025752 395,5 mm anod. alumiini  
 025753 495,5 mm anod. alumiini  
 025754 595,5 mm anod. alumiini  
 025755 695,5 mm anod. alumiini  
 025756 795,5 mm anod. alumiini  
 025757 895,5 mm anod. alumiini  
 025758 995,5 mm anod. alumiini

025760 195,5 mm valkoinen  
 025761 295,5 mm valkoinen  
 025762 395,5 mm valkoinen  
 025763 495,5 mm valkoinen  
 025764 595,5 mm valkoinen  
 025765 695,5 mm valkoinen  
 025766 795,5 mm valkoinen  
 025767 895,5 mm valkoinen  
 025768 995,5 mm valkoinen

025770 195,5 mm musta  
 025771 295,5 mm musta  
 025772 395,5 mm musta  
 025773 495,5 mm musta  
 025774 595,5 mm musta  
 025775 695,5 mm musta  
 025776 795,5 mm musta  
 025777 895,5 mm musta  
 025778 995,5 mm musta

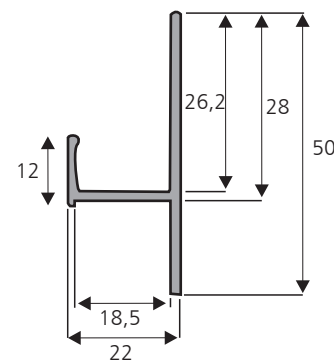
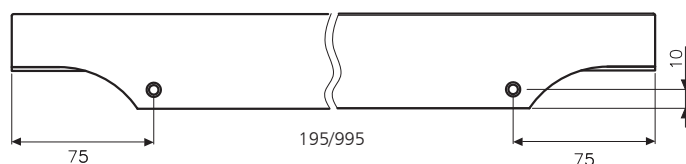

Ø	Ø	∇	∇	∇	∇	∇
-	195,5	22	26,2/50	-	-	-
-	295,5	22	26,2/50	-	-	-
-	395,5	22	26,2/50	-	-	-
-	495,5	22	26,2/50	-	-	-
-	595,5	22	26,2/50	-	-	-
-	695,5	22	26,2/50	-	-	-
-	795,5	22	26,2/50	-	-	-
-	895,5	22	26,2/50	-	-	-
-	995,5	22	26,2/50	-	-	-





## Wing

tuotenro nimike

026940 40 mm harjattu musta  
 026941 40 mm harjattu pronssi  
 026942 40 mm harjattu alumiini  
 026943 40 mm harjattu messinki  
 026944 40 mm harjattu antrasiitti

026945 200 mm harjattu musta  
 026946 200 mm harjattu pronssi  
 026947 200 mm harjattu alumiini  
 026948 200 mm harjattu messinki  
 026949 200 mm harjattu antrasiitti

026950 350 mm harjattu musta  
 026951 350 mm harjattu pronssi  
 026952 350 mm harjattu alumiini  
 026953 350 mm harjattu messinki  
 026954 350 mm harjattu antrasiitti

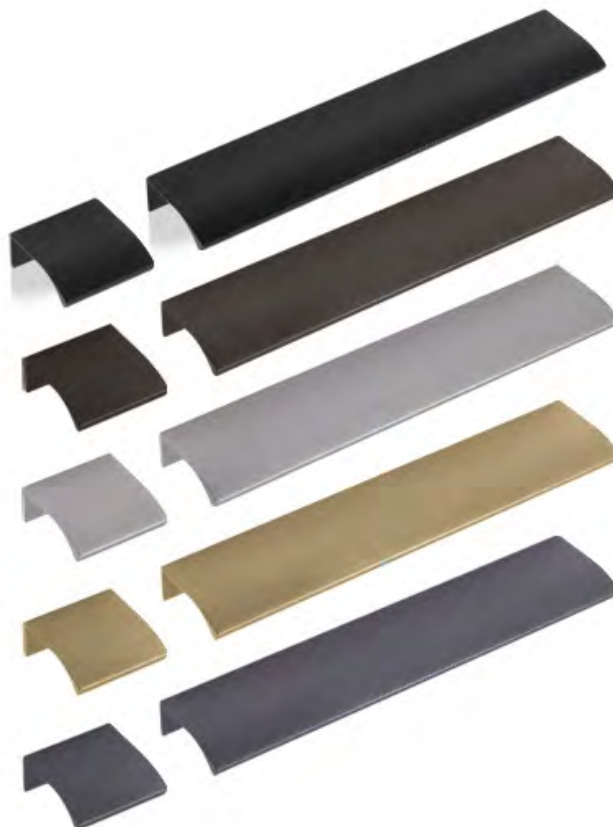

Ø	Ø	Ø	Ø	Ø	Ø
20	40	41	18	-	-
80/80	200	41	18	-	-
160/160	350	41	18	-	-

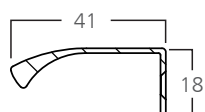



## Bow

tuotenro nimike

- 026955 350 mm harjattu musta
- 026956 350 mm harjattu pronssi
- 026958 350 mm harjattu alumiini

160/160	350	41	18	-	-	-

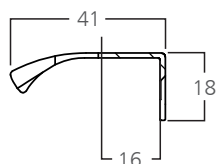



### Rise

tuotenro nimike

026964	80 mm valkoinen
026965	80 mm harjattu musta
026966	80 mm harjattu pronssi
026967	80 mm harjattu alumiini
026968	80 mm mattamusta

64	80	45	18	-	-

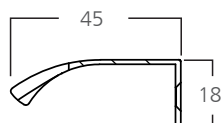

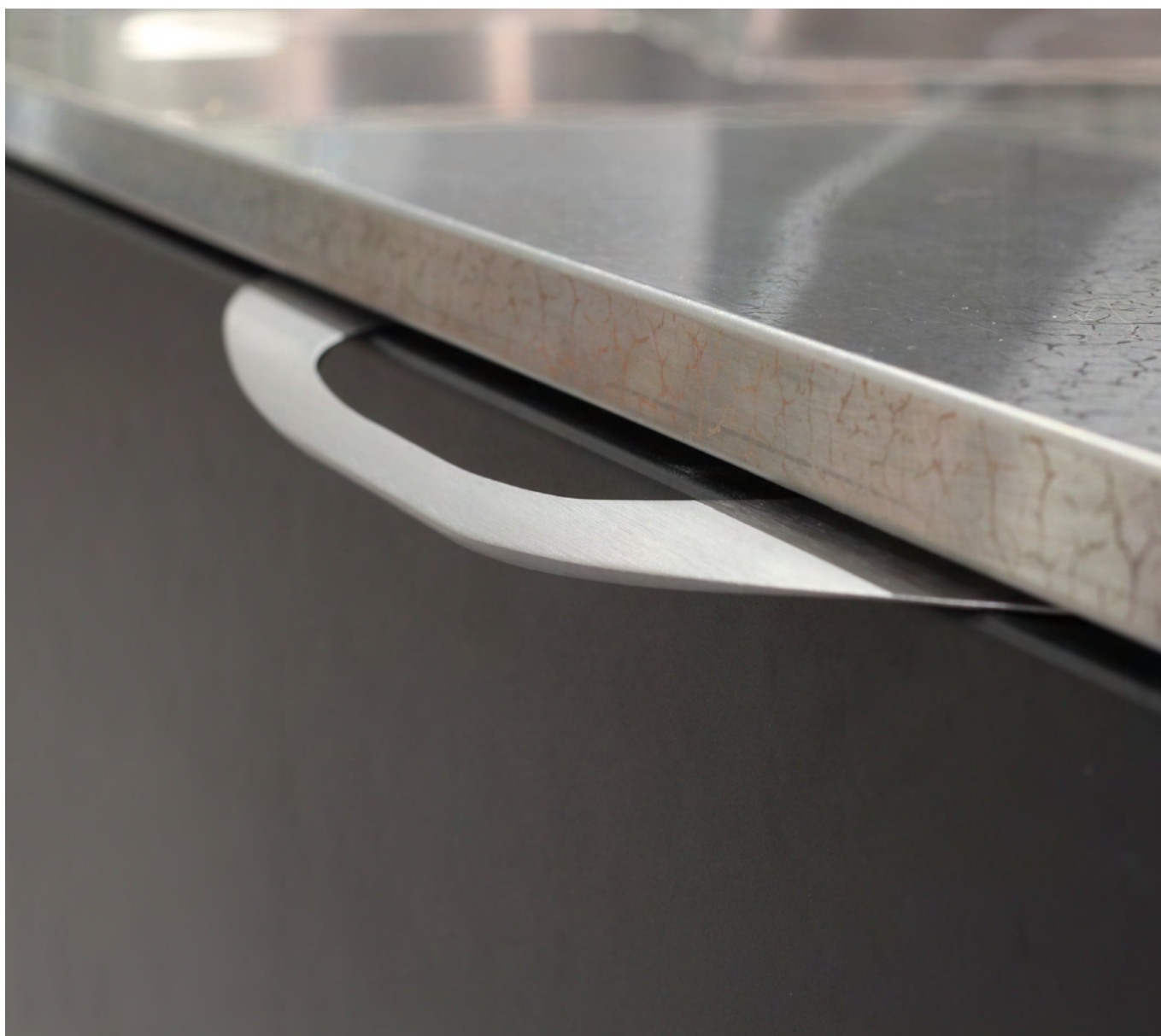

## Diaz

tuotenro nimike

- 026960 350 mm harjattu musta
- 026961 350 mm harjattu pronssi
- 026962 350 mm harjattu alumiini

48/48	350	45	18	-	-

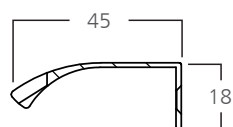



### Falcon

tuotenro nimike

- 026970 350 mm harjattu musta
- 026971 350 mm harjattu pronssi
- 026972 350 mm harjattu alumiini

25/25	350	45	18	-	-

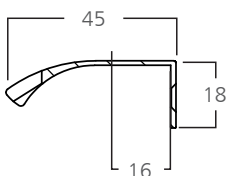



## Vann

tuotenro nimike

022325 128 mm matta musta

022326 128 mm rst-look

022327 128 mm tumma messinki

128	200	20	44	-	25





### Slope

tuotenro nimike

- 026515 200 mm harjattu alumiini
- 026516 350 mm harjattu alumiini
- 026517 200 mm antiikki pronssi
- 026518 350 mm antiikki pronssi

Ø	Ø	Ø	Ø	Ø	Ø
128	200	17	19/38	-	-
256	350	17	19/38	-	-

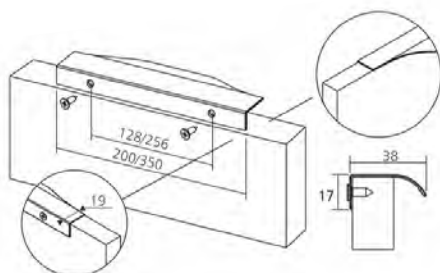





## Tap

tuotenro nimike

027490 Kuppivedin kromi

027491 Kuppivedin matta musta

Ø36	40	12	-	36	25

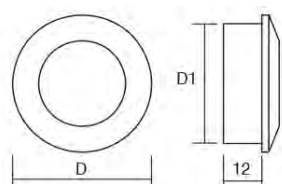



### Cubic

tuotenro nimike

027501 Liukuoven vedin 160 mm valkoinen

027502 Liukuoven vedin 160 mm musta

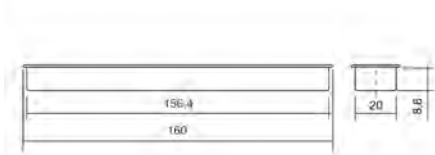



*Camon, harjatut kupari ja messinki*



*Cubix, musta*



*Norma, musta*



*Lungo, musta*